

ENVIRONMENTAL SYSTEMS LLC.

2358 HWY# 23

MORA MN. 55051

Ph. 320-241-7036

06/09/2023

DESIGN

LOCATION: 63170 GROUSE TRAIL SANDSTONE MN

OWNER: MILLE LACS BAND OF OJIBWE

SYSTEM TYPE: TYPE I MOUND

DESIGN FLOW: 2 BEDROOM DESIGNED @ 300 GPD

TREATMENT AREA: 250 SQ.FT.

SLOPE: 7 %

SEPTIC TANK: 2000 GAL. SPLIT/COMBO

PUMP TANK: 1000 GAL.

PUMP: GOULDS WE51

FLOW METER: SJE RHOMBUS

MODEL# EZP11W6COH1JV8G10EP17A22C

KEVIN HERWIG M.P.C.A. 3945

A handwritten signature in black ink, appearing to read "Kevin Herwig", is written over the printed name and title.

ENVIRONMENTAL SYSTEMS LLC.

DESIGN-INSPECTION

2358 HYY#23 MORA MN. 55051

Ph. 320-679-4031

CONSTRUCTION NOTES

**PRODUCT BRAND & MODEL LISTED IN DESIGN MUST BE USED: BROWN-WILBERT 2000HD SPLIT SEPTIC TANK
BROWN-WILBERT 1000 PUMP TANK**

*****PUMP CHAMBER AND PUMP SETTINGS WILL NOT BE CORRECT IF OTHER PRODUCTS ARE USED.**

GOULDS WE511 PUMP

A TWO WAY CLEANOUT IS TO BE INSTALLED 1 FOOT OUTSIDE HOME

**FLOW CONTROL, METER, AND ALARM: SJE RHOMBUS
EZP11W6COH1JV8G10EP17A22C**

IT IS THE DESIGNERS DISCRETION TO APPROVE OR DISAPPROVE SUBSTITUTIONS.THE INSTALLER WILL BE RESPONSIBLE FOR DESIGN CHANGE FEE.

KEVIN HERWIG LIC # 3945

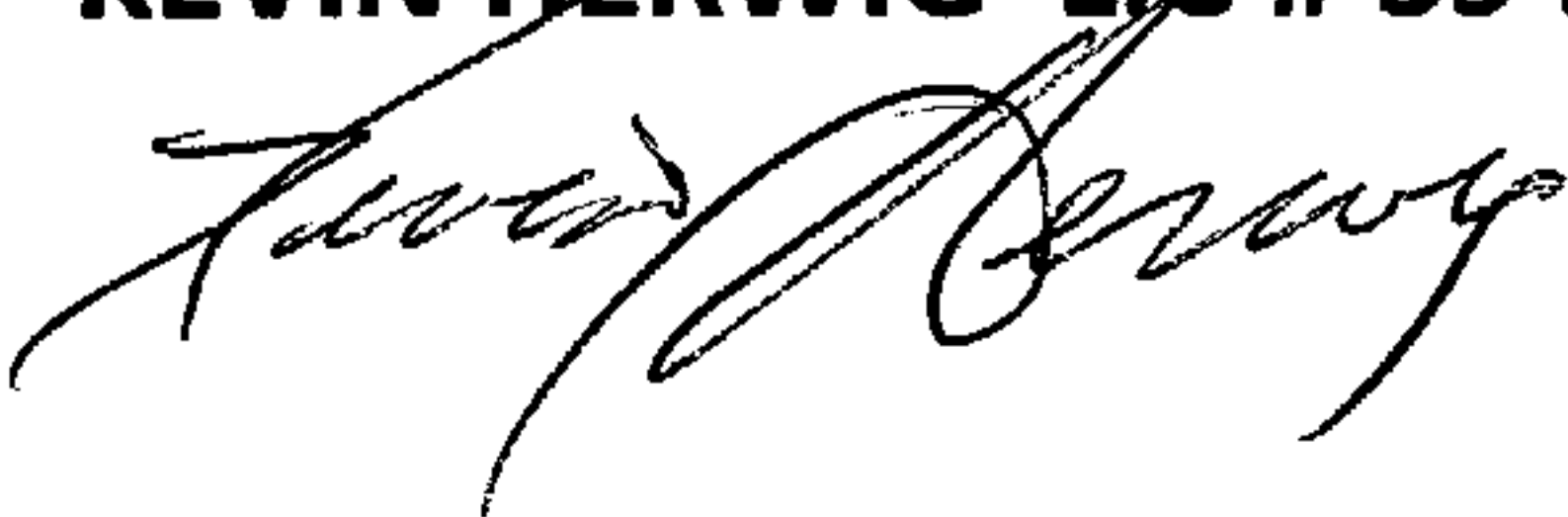



Preliminary Evaluation Worksheet

1. Contact Information v 03.15.2023

Property Owner/Client: Date Completed:

Site Address: Project ID:

Email: Phone:

Mailing Address: Alt Phone:

Legal Description:

Parcel ID: SEC: TWP: RNG:

2. Flow and General System Information

A. Client-Provided Information

Project Type: New Construction Replacement Expansion Repair

Project Use: Residential Other Establishment:

Residential use: # Bedrooms: Dwelling sq.ft.: Unfinished sq.ft.:

Adults: # Children: # Teenagers:

In-home business (Y/N): If yes, describe:

Water-using devices: (check all that apply)

<input type="checkbox"/> Garbage Disposal/Grinder	<input type="checkbox"/> Dishwasher	<input type="checkbox"/> Hot Tub*
<input type="checkbox"/> Sewage pump in basement	<input type="checkbox"/> Water Softener*	<input type="checkbox"/> Sump Pump*
<input type="checkbox"/> Large Bathtub >40 gallons	<input type="checkbox"/> Iron Filter*	<input type="checkbox"/> Self-Cleaning Humidifier*
<input type="checkbox"/> Clothes Washing Machine	<input type="checkbox"/> High Eff. Furnace*	<input type="checkbox"/> Other: <input type="text"/>

* Clear water source - should not go into system

Additional current or future uses:

Anticipated non-domestic waste:

The above is complete & accurate:

Client signature & date

B. Designer-determined Flow and Anticipated Waste Strength Information
Attach additional information as necessary.

Design Flow: GPD Anticipated Waste Type:

Maximum Concentration BOD: mg/L TSS mg/L Oil & Grease mg/L

3. Preliminary Site Information

A. Water Supply Wells

#	Description	Mn. ID#	Well Depth (ft.)	Casing Depth (ft.)	Confining Layer	STA Setback	Source
1	BROKEN OFF	NA					
2							
3							
4							

Additional Well Information:



Preliminary Evaluation Worksheet

Site within 200' of noncommunity transient well (Y/N)	<input type="text" value="No"/>	Yes, source: <input style="width: 100%;" type="text"/>
Site within a drinking water supply management area (Y/N)	<input type="text" value="No"/>	Yes, source: <input style="width: 100%;" type="text"/>
Site in Well Head Protection inner wellhead management zone (Y/N)	<input type="text" value="No"/>	Yes, source: <input style="width: 100%;" type="text"/>
Buried water supply pipes within 50 ft of proposed system (Y/N)	<input type="text" value="No"/>	
B. Site located in a shoreland district/area?	<input type="text" value="No"/>	Yes, name: <input style="width: 100%;" type="text" value="N/A"/>
Elevation of ordinary high water level:	<input type="text" value="N/A"/> ft	Source: <input style="width: 100%;" type="text" value="N/A"/>
Classification: <input style="width: 150px;" type="text" value="N/A"/>	Tank Setback: <input style="width: 50px;" type="text" value="N/A"/> ft.	STA Setback: <input style="width: 50px;" type="text" value="N/A"/> ft.
C. Site located in a floodplain?	<input type="text" value="No"/>	Yes, Type(s): <input style="width: 100%;" type="text" value="N/A"/>
Floodplain designation/elevation (10 Year):	<input type="text" value="N/A"/> ft	Source: <input style="width: 100%;" type="text" value="N/A"/>
Floodplain designation/elevation (100 Year):	<input type="text" value="N/A"/> ft	Source: <input style="width: 100%;" type="text" value="N/A"/>
D. Property Line Id / Source:	<input type="checkbox"/> Owner <input type="checkbox"/> Survey <input checked="" type="checkbox"/> County GIS <input type="checkbox"/> Plat Map <input type="checkbox"/> Other: <input style="width: 100px;" type="text"/>	
E. ID distance of relevant setbacks on map:	<input type="checkbox"/> Water <input type="checkbox"/> Easements <input checked="" type="checkbox"/> Well(s) <input type="checkbox"/> Building(s) <input checked="" type="checkbox"/> Property Lines <input type="checkbox"/> OHWL <input checked="" type="checkbox"/> Other: <input style="width: 100px;" type="text" value="380' TO LAKE"/>	

4. Preliminary Soil Profile Information From Web Soil Survey (attach map & description)

Map Units:	<input style="width: 95%;" type="text" value="NONE"/>	Slope Range:	<input style="width: 95%;" type="text"/>
List landforms:	<input style="width: 98%;" type="text"/>		
Landform position(s):	<input style="width: 98%;" type="text"/>		
Parent materials:	<input style="width: 98%;" type="text"/>		
	Depth to Bedrock/Restrictive Feature: <input style="width: 50px;" type="text"/> in	Depth to Watertable: <input style="width: 50px;" type="text"/> in	
Map Unit Ratings	Septic Tank Absorption Field- At-grade: <input style="width: 90%;" type="text"/>		
	Septic Tank Absorption Field- Mound: <input style="width: 90%;" type="text" value="NONE"/>		
	Septic Tank Absorption Field- Trench: <input style="width: 90%;" type="text"/>		

5. Local Government Unit Information

Name of LGU:	<input style="width: 95%;" type="text" value="MILLE LACS BAND OF OJIBWE"/>
LGU Contact:	<input style="width: 95%;" type="text" value="CARLA"/>
LGU-specific setbacks:	<input style="width: 95%;" type="text"/>
LGU-specific design requirements:	<input style="width: 95%;" type="text"/>
LGU-specific installation requirements:	<input style="width: 95%;" type="text"/>

Notes:

1. Project Information		v 03.15.2023	
Property Owner/Client:	MILLE LACS BAND OF OJIBWE	Project ID: <input type="text"/>	
Site Address:	63170 GROUSE TRAIL SANDSTONE MN	Date Completed: 6/9/2023	
2. Utility and Structure Information			
Utility Locations Identified	<input type="checkbox"/> Gopher State One Call # <input type="text"/>	<input type="checkbox"/> Any Private Utilities: <input type="text"/>	
Locate and Verify (see Site Evaluation map)	<input checked="" type="checkbox"/> Existing Buildings	<input type="checkbox"/> Improvements <input type="checkbox"/> Easements <input type="checkbox"/> Setbacks	
3. Site Information			
Vegetation type(s):	Forest	Landscape position: Shoulder	
Percent slope:	7 %	Slope shape: Linear, Linear Slope direction: northeast	
Describe the flooding or run-on potential of site:	GRADE FOR PROTECTION		
Describe the need for Type III or Type IV system:	<input type="text"/>		
Note:	<input type="text"/>		
Proposed soil treatment area protected? (Y/N):	Yes	If yes, describe: STAKED	
4. General Soils Information			
Filled, Compacted, Disturbed areas (Y/N):	Yes		
If yes, describe:	SIGN OF FENCED AREA AT ONE TIME		
Soil observations were conducted in the proposed system location (Y/N):	Yes		
A soil observation in the most limiting area of the proposed system (Y/N):	Yes		
Number of soil observations:	3	Soil observation logs attached (Y/N): Yes	
Percolation tests performed & attached (Y/N):	No		
5. Phase I. Reporting Information			
Limiting Condition*:	Depth	Elevation	<i>*Most Restrictive Depth Identified from List Below</i>
Periodically saturated soil:	18 in	93.1 ft	Soil Texture: Loam
Standing water:	<input type="text"/> in	<input type="text"/> ft	Percolation Rate: <input type="text"/> min/inch
Bedrock:	<input type="text"/> in	<input type="text"/> ft	Soil Hyd Loading Rate: 0.52 gpd/sq.ft
Benchmark Elevation:	100.0 ft	Elevations and Benchmark on map? (Y/N):	Yes
Benchmark Elevation Location:	BOTTOM OF SIDING		
Differences between soil survey and field evaluation:	NO RECORD		
Site evaluation issues / comments:	<input type="text"/>		
Anticipated construction issues:	<input type="text"/>		

Soil Observation Log

Project ID: **v 03.15.2023**

Client: MILLE LACS BAND OF OJIBWE **Location / Address:** 63170 GROUSE TRAIL SANDSTONE MN

Soil parent material(s): (Check all that apply) Outwash Lacustrine Loess Till Alluvium Bedrock Organic Matter Disturbed/Fill

Landscape Position: Shoulder **Slope %:** 7.0 **Slope shape:** Linear, Linear **Flooding/Run-On potential:**

Vegetation: Forest **Soil survey map units:** C71C **Surface Elevation-Relative to benchmark:** 94.8

Date/Time of Day/Weather Conditions: 6/9/2023 1PM **OVERCAST** **Limiting Layer Elevation:** 93.6

Observation #/Location: 1 NE **Observation Type:** Pit

Depth (in)	Texture	Rock Frag. %	Matrix Color(s)	Mottle Color(s)	Redox Kind(s)	Indicator(s)	Structure-----		
							Shape	Grade	Consistence
0-3	Fine Sandy Loam	<35	10YR 3/1				Granular	Weak	Friable
3-14	Fine Sandy Loam	,35	7.5YR 4/4				Platy	Weak	Friable
14-24	Fine Sandy Loam	<35	7.5YR 4/4	5YR 5/6 7.5YR 6/3	Concentrations Depletions	S2 S4	Blocky	Weak	Friable

Comments:

I hereby certify that I have completed this work in accordance with all applicable ordinances, rules and laws.

KEVIN HERWIG **3945** **6/9/2023**
 (Designer/Inspector) (License #) (Date)

Optional Verification: I hereby certify that this soil observation was verified according to Minn. R. 7082.0500 subp. 3 A. The signature below represents an infield verification of the periodically saturated soil or bedrock at the proposed soil treatment and dispersal site.

 (LGU/Designer/Inspector) _____ _____
 (Signature) (Cert #) (Date)



Soil Observation Log

Project ID: v 03.15.2023

Client: MILLE LACS BAND OF OJIBWE Location / Address: 63170 GROUSE TRAIL SANDSTONE MN

Soil parent material(s): (Check all that apply) Outwash Lacustrine Loess Till Alluvium Bedrock Organic Matter Disturbed/Fill

Landscape Position: Shoulder Slope %: 7.0 Slope shape: Linear, Linear Flooding/Run-On potential: 93.7

Vegetation: Forest Soil survey map units: C71C Surface Elevation-Relative to benchmark: 93.7

Date/Time of Day/Weather Conditions: 6/9/2023 1PM OVERCAST Limiting Layer Elevation: 92.6

Observation #/Location: 2 E CENTER Observation Type: Pit

Depth (in)	Texture	Rock Frag. %	Matrix Color(s)	Mottle Color(s)	Redox Kind(s)	Indicator(s)	Structure		Consistence
							Shape	Grade	
0-4	Fine Sandy Loam	<35	10YR 3/4				Granular	Weak	Friable
4-17	Fine Sandy Loam	,35	7.5YR 4/4				Platy	Weak	Friable
17-22	Fine Sandy Loam	<35	5YR 4/4	5YR 5/6	Concentrations	52	Blocky	Weak	Friable

Comments:

KEVIN HERWIG (Designer/Inspector) 3945 (License #) 6/9/2023 (Date)

Optional Verification: I hereby certify that this soil observation was verified according to Minn. R. 7082.0500 subp. 3 A. The signature below represents an infield verification of the periodically saturated soil or bedrock at the proposed soil treatment and dispersal site.

(LGU/Designer/Inspector) (Signature) (Cert #) (Date)



Soil Observation Log

Project ID: **v 03.15.2023**

Client: **MILLE LACS BAND OF OJIBWE** Location / Address: **63170 GROUSE TRAIL SANDSTONE MN**

Soil parent material(s): (Check all that apply) Outwash Lacustrine Loess Till Alluvium Bedrock Organic Matter Disturbed/Fill

Landscape Position: **Shoulder** Slope %: **7.0** Slope shape: **Linear, Linear** Flooding/Run-On potential: _____

Vegetation: **Forest** Soil survey map units: **C71C** Surface Elevation-Relative to benchmark: **94.3**

Date/Time of Day/Weather Conditions: **6/9/2023 1:15 PM** OVERCAST Limiting Layer Elevation: _____

Observation #/Location: **1 NE** Observation Type: **Pit**

Depth (in)	Texture	Rock Frag. %	Matrix Color(s)	Mottle Color(s)	Redox Kind(s)	Indicator(s)	Structure-----		
							Shape	Grade	Consistence
0-4	Fine Sandy Loam	<35	10YR 3/1				Granular	Weak	Friable
4-18	Fine Sandy Loam	,35	7.5YR 4/4				Platy	Weak	Friable
18-24	Loamy Fine Sand	<35	5YR 4/6				Blocky	Weak	Friable

Comments: _____

I hereby certify that I have completed this work in accordance with all applicable ordinances, rules and laws.

KEVIN HERWIG (Designer/Inspector) **3945** (License #) **6/9/2023** (Date)

Optional Verification: I hereby certify that this soil observation was verified according to Minn. R. 7082.0500 subp. 3 A. The signature below represents an infield verification of the periodically saturated soil or bedrock at the proposed soil treatment and dispersal site.

(Signature)

(Cert #)

(Date)

Project ID:

v 03.15.2023

Property Owner/Client: MILLE LACS BAND OF OJIBWE

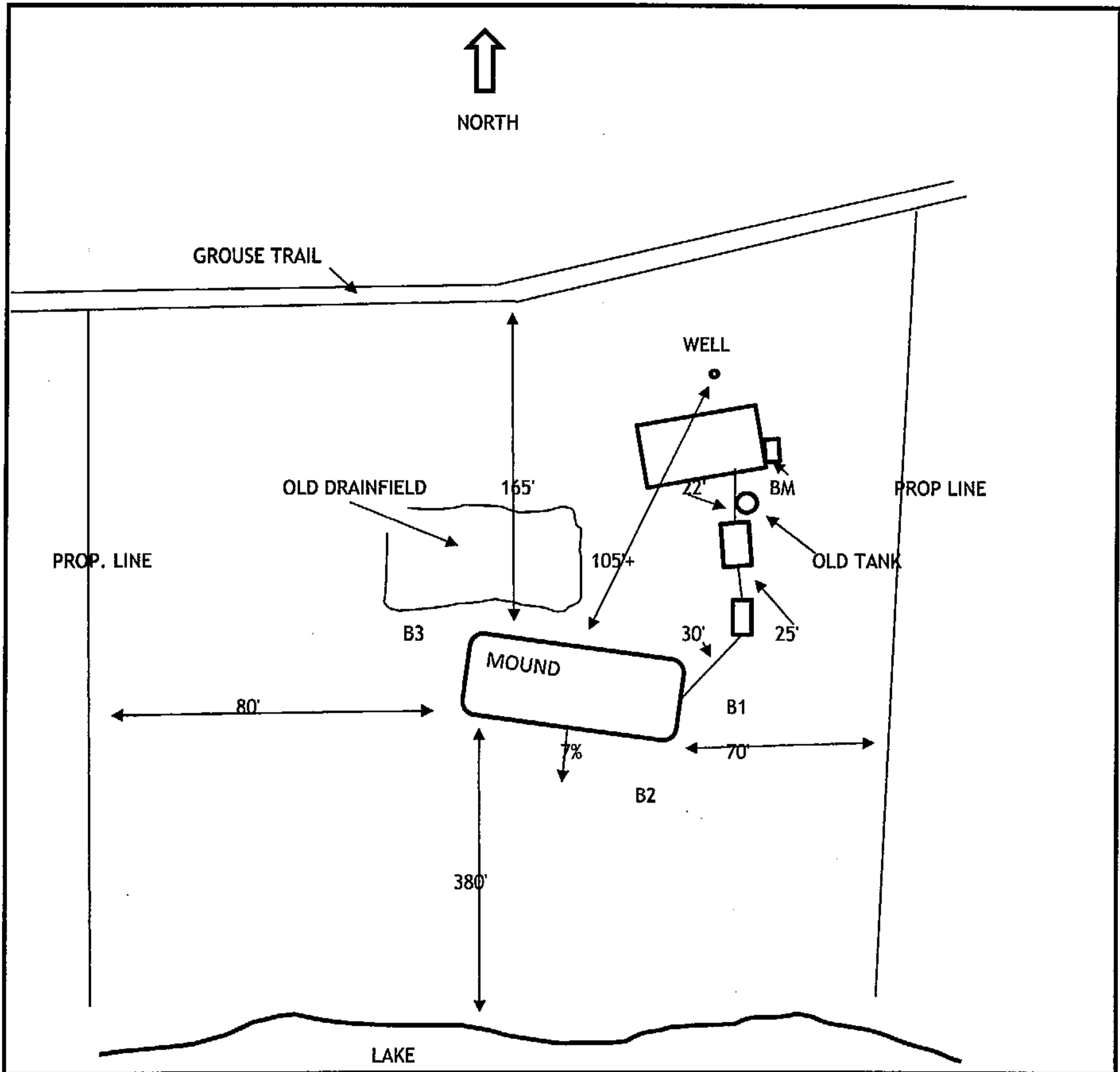

Map scale:

Indicated north

Show slope/contours

Elevations in feet

Benchmark: ft

System Corners:

Soil Observation:

NW:	<input type="text" value="94.6"/> ft
NE:	<input type="text" value="94.55"/> ft
SW:	<input type="text" value="94.35"/> ft
SE:	<input type="text" value="93.9"/> ft

#1:	<input type="text" value="94.8"/> ft
#2:	<input type="text" value="93.7"/> ft
#3:	<input type="text" value="94.3"/> ft
#4:	<input type="text" value=""/> ft

TANK INLET	<input type="text" value="94.9"/> ft
Other:	
<u>PUMP TANL INLET</u>	<input type="text" value="93.5"/> ft
	<input type="text" value=""/> ft

Date Completed:

1. PROJECT INFORMATION		v 03.15.2023
Property Owner/Client:	<input type="text" value="MILLE LACS BAND OF OJIBWE"/>	Project ID: <input type="text"/>
Site Address:	<input type="text" value="63170 GROUSE TRAIL SANDSTONE MN"/>	Date: <input type="text" value="06/09/23"/>
Email Address:	<input type="text"/>	Phone: <input type="text"/>
2. DESIGN FLOW & WASTE STRENGTH <i>Attach waste strength data/estimated strength for Other Establishments</i>		
Design Flow:	<input type="text" value="300"/> GPD	Anticipated Waste Type: <input type="text"/>
BOD:	<input type="text"/> mg/L	TSS: <input type="text"/> mg/L
		Oil & Grease: <input type="text"/> mg/L
Treatment Level:	<input type="text" value="C"/>	<i>Select Treatment Level C for residential septic tank effluent</i>
3. HOLDING TANK SIZING		
Minimum Capacity: Residential =1000 gal or 400 gal/bedroom, Other Establishment = Design Flow x 5.0, Minimum size 1000 gallons		
Code Minimum Holding Tank Capacity:	<input type="text"/> Gallons	with <input type="text"/> Tanks or Compartments
Recommended Holding Tank Capacity:	<input type="text"/> Gallons	with <input type="text"/> Tanks or Compartments
Type of High Level Alarm:	<input type="text"/>	(Set @ 75% tank capacity)
Comments:	<input type="text"/>	
4. SEPTIC TANK SIZING		
A. Residential dwellings:		
Number of Bedrooms (Residential):	<input type="text" value="2"/>	
Code Minimum Septic Tank Capacity:	<input type="text" value="1000"/> Gallons	with <input type="text"/> Tanks or Compartments
Recommended Septic Tank Capacity:	<input type="text" value="2000"/> Gallons	with <input type="text" value="2"/> Tanks or Compartments
Effluent Screen & Alarm (Y/N):	<input type="text" value="Yes"/>	Model/Type: <input type="text" value="POLYLOK PL-122"/>
B. Other Establishments:		
Waste received by:	<input type="text"/>	<input type="text"/> GPD x <input type="text"/> Days Hyd. Retention Time
Code Minimum Septic Tank Capacity:	<input type="text"/> Gallons	with <input type="text"/> Tanks or Compartments
Recommended Septic Tank Capacity:	<input type="text"/> Gallons	with <input type="text"/> Tanks or Compartments
Effluent Screen & Alarm (Y/N):	<input type="text"/>	Model/Type: <input type="text"/>
* Other Establishments Require Department of Labor and Industry Approval and Inspection for Building Sewer *		
5. PUMP TANK SIZING		
Soil Treatment Dosing Tank		Other Component Dosing Tank:
Pump Tank Capacity (Minimum):	<input type="text" value="500"/> Gal	Pump Tank Capacity (Minimum): <input type="text"/> Gal
Pump Tank Capacity (Recommended):	<input type="text" value="1000"/> Gal	Pump Tank Capacity (Recommended): <input type="text"/> Gal
Pump Req:	<input type="text" value="18.0"/> GPM	Total Head: <input type="text" value="16.3"/> ft
Supply Pipe Dia.	<input type="text" value="2.00"/> in	Dose Vol: <input type="text" value="74.0"/> gal
		Supply Pipe Dia. <input type="text"/> in
		Dose Vol: <input type="text"/> Gal
* Flow measurement device must be incorporated for any system with a pump: Elapsed Time Meter and/or Event Counter *		

6. SYSTEM AND DISTRIBUTION TYPE

Project ID:

Soil Treatment Type:	Mound	Distribution Type:	Pressure Distribution-Level
Elevation Benchmark:	100.0 ft	Benchmark Location:	ENTRY STOOP
MPCA System Type:	Type I	Distribution Media:	Rock
Type III/IV/V Details:			

7. SITE EVALUATION SUMMARY:

Describe Limiting Condition: Redoximorphic Features/Saturated Soils

Layers with >35% Rock Fragments? (yes/no) No If yes, describe below: % rock and layer thickness, amount of soil credit and any additional information for addressing the rock fragments in this design.

Note:

	Depth	Depth	Elevation of Limiting Condition	
Limiting Condition:	18 inches	1.5 ft	93.10 ft	<i>Critical for system compliance</i>
Minimum Req'd Separation:	36 inches	3.0 ft		<i>Distribution Elevation >Code Max Depth</i>
Code Max System Depth*:	Mound inches	-1.5 ft	96.10 ft	Elevation OK

*This is the maximum depth to the bottom of the distribution media for required separation. Negative Depth (ft) requires a mound.

Designed Distribution Elevation: 96.1 ft Minimum Sand Depth: 18.0 inches

A. Soil Texture: Loam B. Organic Loading Rate (optional): lbs/sq.ft/day 0

C. Soil Hyd. Loading Rate: 0.68 GPD/ft² D: Percolation Rate: MPI

E. Contour Loading Rate: 8 Note:

F. Measured Land Slope: 7.0 % Note:

Comments:

8. SOIL TREATMENT AREA DESIGN SUMMARY

Trench:

Dispersal Area		sq.ft	Sidewall Depth		in	Trench Width		ft
Total Lineal Feet		ft	No. of Trenches			Code Max. Trench Depth		in
Contour Loading Rate		ft	Minimum Length		ft	Designed Trench Depth		in

Bed:

Dispersal Area		sq.ft	Sidewall Depth		in	Maximum Bed Depth		in
Bed Width		ft	Bed Length		ft	Designed Bed Depth		in

Mound:

Dispersal Area	250.0	sq.ft	Bed Length	25.0	ft	Bed Width	10.0	ft
Absorption Width	18.0	ft	Clean Sand Lift	1.5	ft	Berm Width (0-1%)		ft
Upslope Berm Width	8.4	ft	Downslope Berm	22.8	ft	Endslope Berm Width	16.4	ft
Total System Length	57.8	ft	System Width	41.2	ft	Contour Loading Rate	12.0	gal/ft



Project ID: _____

At-Grade:

Dispersal Area sq.ft Bed Length ft Bed Width ft
 Upslope Berm ft Downslope Berm ft Finished Height ft
 System Length ft Endslope Berm ft System Width ft

Level & Equal Pressure Distribution Soil Treatment Area

No. of Laterals Lateral Diameter in Lateral Spacing ft
 Perforation Spacing ft Perforation Diameter in Drainback Volume gal
 Min Dose Volume gal Max Dose Volume gal Total Dosing Volume gal

Non-Level and Unequal Pressure Distribution Soil Treatment Area

	Elevation (ft)	Pipe Size (in)	Pipe Volume (gal/ft)	Pipe Length (ft)	Perf Size (in)	Spacing (ft)	Spacing (in)	Minimum Dose Volume <input type="text"/> gal
Lateral 1								
Lateral 2								
Lateral 3								
Lateral 4								
Lateral 5								
Lateral 6								
								Maximum Dose Volume <input type="text"/> gal
								Total Dosing Volume <input type="text"/> gal

9. Organic Loading and Additional Info for At-Risk, HSW or Type IV Design

Organic Loading to Soil Treatment

A. Starting BOD Concentration = Design Flow X 0.7 X Starting BOD (mg/L) X 8.35 ÷ 1,000,000
 gpd X mg/L X 8.35 ÷ 1,000,000 = lbs. BOD/day (Organic Loading Design)

B. Organic Loading to Soil Treatment Area: (enter loading value in 7B)
 mg/L X gpd X 0.7 X 8.35 ÷ 1,000,000 ÷ sq.ft = lbs./day/sqft

HSW Technology Strength Reduction

A. Starting BOD Concentration = Design Flow X Starting BOD (mg/L) X 8.35 ÷ 1,000,000
 gpd X mg/L X 8.35 ÷ 1,000,000 = lbs. BOD/day (HSW Technology Design)

B. Target BOD Concentration = Design Flow X Target BOD (mg/L) X 8.35 ÷ 1,000,000
 gpd X mg/L X 8.35 ÷ 1,000,000 = lbs. BOD/day (HSW Technology Design)
 Lbs. BOD To Be Removed: lbs. BOD/day (HSW Technology Design)

Pretreatment Technology: *Must Meet or Exceed Target

Disinfection Technology: *Required for Levels A & B

10. Comments/Special Design Considerations:

I hereby certify that I have completed this work in accordance with all applicable ordinances, rules and laws.

KEVIN HERWIG
 (Designer)

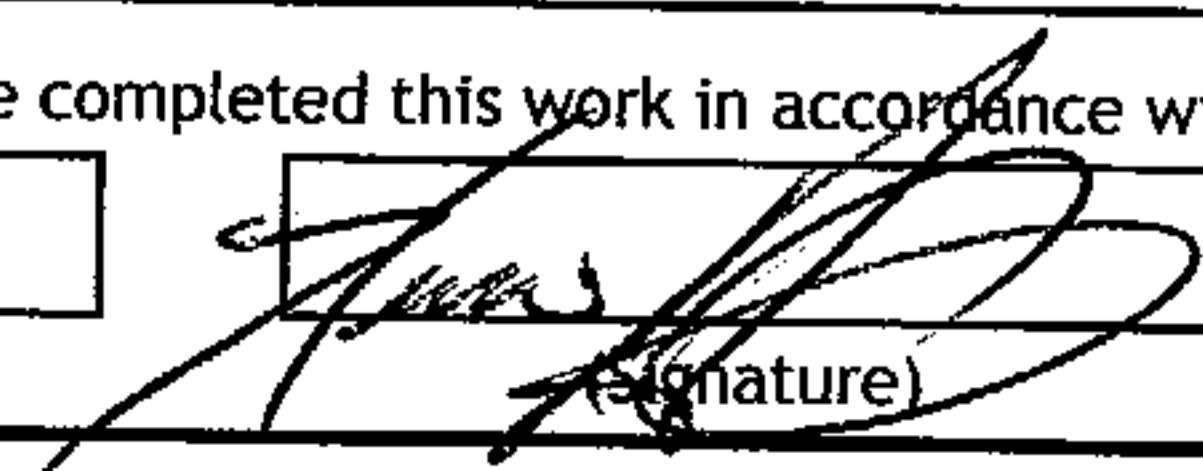
 (Signature)

3945
 (License #)

6/9/2023
 (Date)



1. SYSTEM SIZING: Project ID: _____ v 03.15.2023

- A. Design Flow: GPD
- B. Soil Loading Rate: GPD/sqft
- C. Depth to Limiting Condition: ft
- D. Percent Land Slope: %
- E. Media (Sand) Loading Rate: GPD/sqft
- F. Mound Absorption Ratio:

Percolation Rate (MPI)	Treatment Level C		Treatment Level A, A-2, B	
	Absorption Area Loading Rate (gpd/ft ²)	Mound Absorption Ratio	Absorption Area Loading Rate (gpd/ft ²)	Mound Absorption Ratio
<0.1	-	1	-	1
0.1 to 5	1.2	1	1.6	1
0.1 to 5 (fine sand and loamy fine sand)	0.6	2	1	1.6
6 to 16	0.78	1.5	1	1.6
16 to 30	0.6	2	0.78	2
31 to 45	0.5	2.4	0.78	2
46 to 60	0.45	2.6	0.6	2.6
61 to 120	-	5	0.3	5.3
>120	-	-	-	-

Measured Perc. Rate	OR	Texture-derived mound absorption ratio	Contour Loading Rate:
≤ 60mpi	← →	1.0, 1.3, 2.0, 2.4, 2.6	→ ≤12
61-120 mpi	← OR →	5.0	→ ≤12
≥ 120 mpi*	← →	>5.0*	→ ≤6*

*Systems with these values are not Type I systems. Contour Loading Rate (linear loading rate) is a recommended value.

2. DISPERSAL MEDIA SIZING

A. Hydraulic Absorption Required Bottom Area: Design Flow (1A) ÷ Design Media Loading Rate(1E)

GPD ÷ GPD/sqft = sq.ft

Organic Sizing (OPTIONAL)

B. Organic Absorption Bed Area = Organic Loading (Summary 9A) ÷ Organic Soil Loading Rate (Summary 7B)

lbs BOD ÷ lbs BOD/sq.ft = sq.ft

C. Required Bed Area = Greater of Hydraulic (1D) or Organic Bed Area (1E) sq.ft

D. Designed Dispersal Media Area: sq.ft *Optional upsizing of area to be larger than 2C*

B. Enter Dispersal Bed Width: ft *Can not exceed 10 feet*

C. Calculate Contour Loading Rate: Bed Width(2B) X Design Media Loading Rate(1E)

ft X GPD/sqft = gal/ft *Can not exceed Table 1*

D. Calculate Minimum Dispersal Bed Length: Dispersal Bed Area(2A) ÷ Bed Width(2B)

sqft ÷ ft = ft

If a larger dispersal media Length is desired, enter size: ft

3. ABSORPTION AREA SIZING

A. Calculate Absorption Width: Bed Width(2B) X Mound Absorption Ratio(1F)

ft X = ft

B. For slopes >1%, the Absorption Width is measured downhill from the upslope edge of the Bed.

Calculate Downslope Absorption Width: Absorption Width(1F) - Bed Width(2B)

ft - ft = ft

4. DISTRIBUTION MEDIA:

Project ID:

Select Dispersal Media:

Enter Either 4A or 4B

A. Rock Depth Below Distribution Pipe

in

B. Registered Media

Registered Media Depth in

Check registered product information for specific application details and design

Specific Media Comments:

5. MOUND SIZING

Project ID:

A. Clean Sand Lift: Required Separation - Depth to Limiting Condition = Clean Sand Lift (1 ft minimum)

ft - ft = ft Design Sand Lift (optional):

B. Upslope Height: Clean Sand Lift(6A) + Depth of Media(4AorB) + Depth to Cover Pipe+ Depth of Cover (1 ft)

ft + ft + ft + ft = ft

Land Slope %		0	1	2	3	4	5	6	7	8	9	10	11	12
Upslope Berm Ratio	3:1	3.00	2.91	2.83	2.75	2.68	2.61	2.54	2.48	2.42	2.36	2.31	2.26	2.21
	4:1	4.00	3.85	3.70	3.57	3.45	3.33	3.23	3.12	3.03	2.94	2.86	2.78	2.70

C. Select Upslope Berm Multiplier (based on land slope):

D. Calculate Upslope Berm Width: Multiplier (5C) X Upslope Mound Height (5B)

X ft = ft

E. Calculate Drop in Elevation Under Bed: Bed Width(2B) X Land Slope(1D) ÷ 100 = Drop (ft)

ft X % ÷ 100 = ft

F. Calculate Downslope Mound Height: Upslope Height(5B) + Drop in Elevation(5E)

ft + ft = ft

Land Slope %		0	1	2	3	4	5	6	7	8	9	10	11	12
Downslope Berm Ratio	3:1	3.00	3.09	3.19	3.30	3.41	3.53	3.66	3.80	3.95	4.11	4.29	4.48	4.69
	4:1	4.00	4.17	4.35	4.54	4.76	5.00	5.26	5.56	5.88	6.25	6.67	7.14	7.69

G. Select Downslope Berm Multiplier (based on land slope):

H. Calculate Downslope Berm Width: Downslope Multiplier(5G) X Downslope Height (5F)

x ft = ft

I. Calculate Minimum Berm to Cover Absorption Area: Downslope Absorption Width(3A) + 4 feet

ft + ft = ft

J. Design Downslope Berm = greater of 5H and 5I: ft

K. Select Endslope Berm Multiplier: (usually 3.0 or 4.0)

L. Calculate Endslope Berm Width = Endslope Berm Multiplier(5K) X Downslope Mound Height(5F)

X ft = ft

M. Calculate Mound Width: Upslope Berm Width(5D) + Bed Width(2B) + Downslope Berm Width(5J)

ft + ft + ft = ft

N. Calculate Mound Length: Endslope Berm Width (5L) + Bed Length(2D) + Endslope Berm Width(5L)

ft + ft + ft = ft

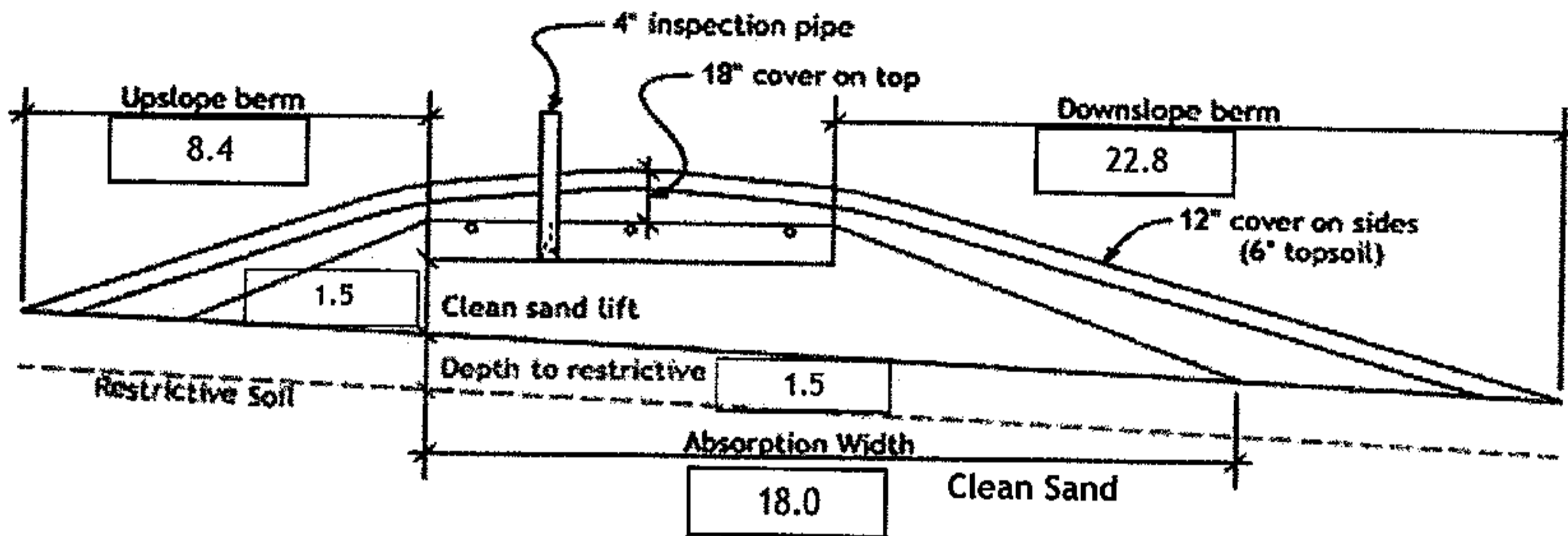
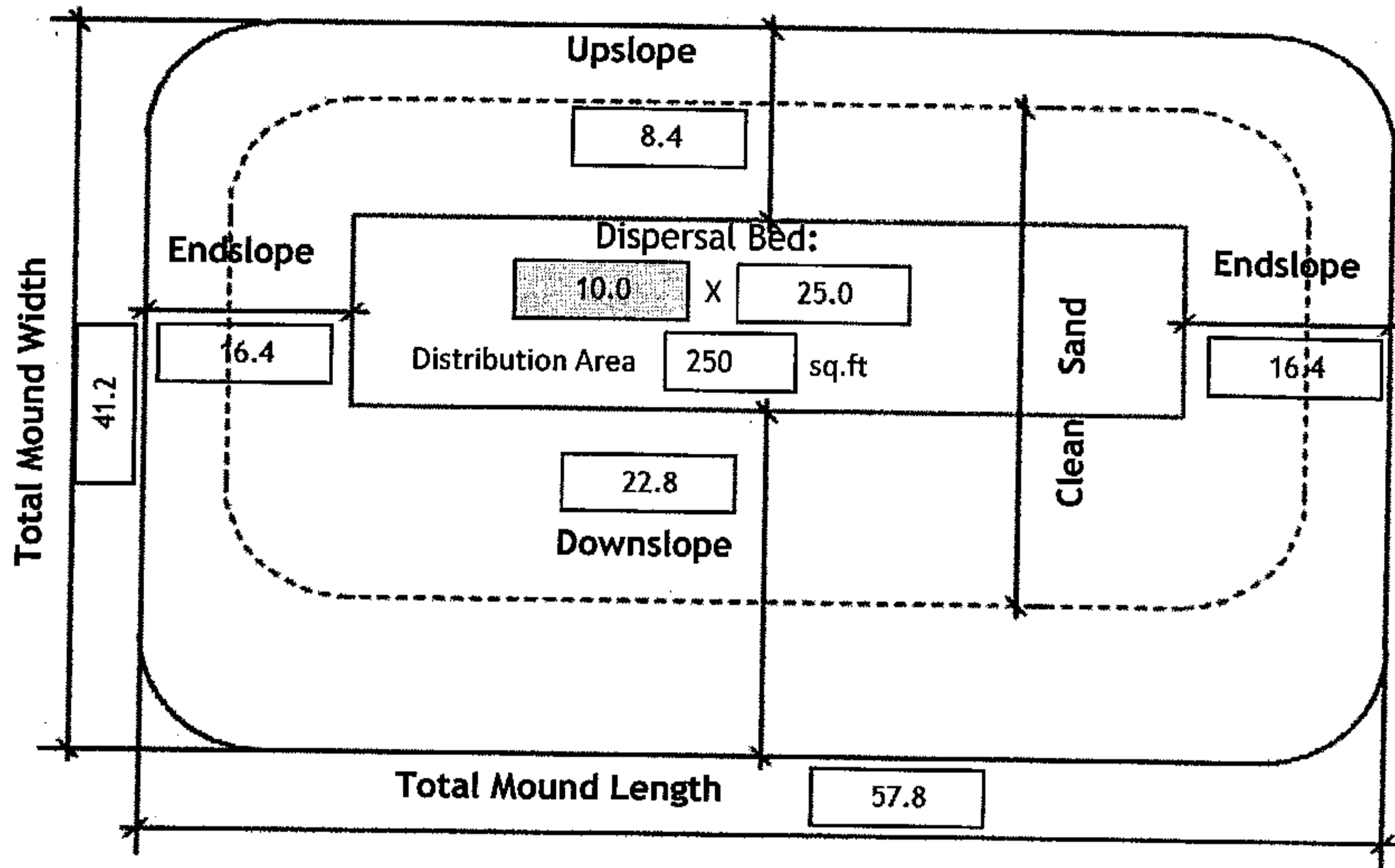

Required Separation:	<input type="text" value="36"/> (in)	Elevation to Benchmark	
Distribution Media:	<input type="text" value="Rock"/>	Elevation Limiting Layer:	<input type="text" value="93.1"/> ft
Media Depth:	<input type="text" value="6.0"/> (in)	Elevation required Separation:	<input type="text" value="96.1"/> ft
Manifold Connection:	<input type="text" value="End"/>	Elevation Distribution Media Bottom:	<input type="text" value="96.1"/> ft
Lateral Pipe Diameter:	<input type="text" value="2.00"/> (in)	Elevation Top of Media(min):	<input type="text" value="97.0"/> ft
Perforation Size:	<input type="text" value="1/4"/> (in)	Elevation Top of System(min):	<input type="text" value="98.0"/> ft
		Perforation Spacing:	<input type="text" value="36.0"/> (in)

If Split and Non-Level Pressure Distribution Used: See Non-Level Pressure Distribution Form

Comments:



Mound Materials Worksheet

Project ID:

v 03.15.2023

A. Rock Volume: (Rock Below Pipe + Rock to cover pipe (pipe outside dia + ~2 inch) X Bed Length X Bed Width = Volume

$$(\boxed{6} \text{ in} + \boxed{5.0} \text{ in}) \div 12 \times \boxed{25.0} \text{ ft} \times \boxed{10.0} \text{ ft} = \boxed{229.2} \text{ cu.ft}$$

Divide cu.ft by 27 cu.ft/cu.yd to calculate cubic yards: $\boxed{229.2} \text{ cu.ft} \div 27 = \boxed{8.5} \text{ cu.yd}$

Add 30% for constructability: $\boxed{8.5} \text{ cu.yd} \times 1.3 = \boxed{11.0} \text{ cu.yd}$

B. Calculate Clean Sand Volume:

Volume Under Rock bed: Average Sand Depth x Media Width x Media Length = cubic feet

$$\boxed{1.9} \text{ ft} \times \boxed{10.0} \text{ ft} \times \boxed{25} \text{ ft} = \boxed{463} \text{ cu.ft}$$

For a Mound on a slope from 0-1%

Volume from Length = ((Upslope Mound Height - 1) X Absorption Width Beyond Bed X Media Bed Length)

$$\boxed{} \text{ ft} - 1) \times \boxed{} \times \boxed{} \text{ ft} = \boxed{}$$

Volume from Width = ((Upslope Mound Height - 1) X Absorption Width Beyond Bed X Media Bed Width)

$$\boxed{} \text{ ft} - 1) \times \boxed{} \times \boxed{} \text{ ft} = \boxed{}$$

Total Clean Sand Volume: Volume from Length + Volume from Width + Volume Under Media

$$\boxed{} \text{ cu.ft} + \boxed{} \text{ cu.ft} + \boxed{} \text{ cu.ft} = \boxed{} \text{ cu.ft}$$

For a Mound on a slope greater than 1%

Upslope Volume: ((Upslope Mound Height - 1) x 3 x Bed Length) ÷ 2 = cubic feet

$$((\boxed{3.4} \text{ ft} - 1) \times 3.0 \text{ ft} \times \boxed{25.0}) \div 2 = \boxed{90.0} \text{ cu.ft}$$

Downslope Volume: ((Downslope Height - 1) x Downslope Absorption Width x Media Length) ÷ 2 = cubic feet

$$((\boxed{4.1} \text{ ft} - 1) \times \boxed{8.0} \text{ ft} \times \boxed{25.0}) \div 2 = \boxed{310.0} \text{ cu.ft}$$

Endslope Volume: (Downslope Mound Height - 1) x 3 x Media Width = cubic feet

$$(\boxed{4.1} \text{ ft} - 1) \times 3.0 \text{ ft} \times \boxed{10.0} \text{ ft} = \boxed{93.0} \text{ cu.ft}$$

Total Clean Sand Volume: Upslope Volume + Downslope Volume + Endslope Volume + Volume Under Media

$$\boxed{90.0} \text{ cu.ft} + \boxed{310.0} \text{ cu.ft} + \boxed{93.0} \text{ cu.ft} + \boxed{462.5} \text{ cu.ft} = \boxed{955.5} \text{ cu.ft}$$

Divide cu.ft by 27 cu.ft/cu.yd to calculate cubic yards: $\boxed{955.5} \text{ cu.ft} \div 27 = \boxed{35.4} \text{ cu.yd}$

Add 30% for constructability: $\boxed{35.4} \text{ cu.yd} \times 1.3 = \boxed{46.0} \text{ cu.yd}$

C. Calculate Sandy Berm Volume:

Total Berm Volume (approx.): ((Avg. Mound Height - 0.5 ft topsoil) x Mound Width x Mound Length) ÷ 2

$$(\boxed{3.8} - 0.5) \text{ ft} \times \boxed{41.2} \text{ ft} \times \boxed{57.8} \text{ ft} \div 2 = \boxed{3872.3} \text{ cu.ft}$$

Total Mound Volume - Clean Sand volume - Rock Volume = cubic feet

$$\boxed{3872.3} \text{ cu.ft} - \boxed{955.5} \text{ cu.ft} - \boxed{229.2} \text{ cu.ft} = \boxed{2687.7} \text{ cu.ft}$$

Divide cu.ft by 27 cu.ft/cu.yd to calculate cubic yards: $\boxed{2687.7} \text{ cu.ft} \div 27 = \boxed{99.5} \text{ cu.yd}$

Add 30% for constructability: $\boxed{99.5} \text{ yd}^3 \times 1.3 = \boxed{129.4} \text{ cu.yd}$

D. Calculate Topsoil Material Volume: Total Mound Width X Total Mound Length X .5 ft

$$\boxed{41.2} \text{ ft} \times \boxed{57.8} \text{ ft} \times 0.5 \text{ ft} = \boxed{1191.5} \text{ cu.ft}$$

Divide cu.ft by 27 cu.ft/cu.yd to calculate cubic yards: $\boxed{1191.5} \text{ cu.ft} \div 27 = \boxed{44.1} \text{ cu.yd}$

Add 30% for constructability: $\boxed{44.1} \text{ cu.yd} \times 1.3 = \boxed{57.4} \text{ cu.yd}$

Project ID: _____ v 03.15.2023

- Media Bed Width: ft
- Minimum Number of Laterals in system/zone = Rounded up number of $[(\text{Media Bed Width} - 4) \div 3] + 1$.
 $[(\text{ } 10 \text{ } - 4) \div 3] + 1 = \text{ } 3 \text{ } \text{laterals}$ *Does not apply to at-grades*
- Designer Selected Number of Laterals: laterals
Cannot be less than line 2 (Except in at-grades)
- Select Perforation Spacing: ft
- Select Perforation Diameter Size: in
- Length of Laterals = Media Bed Length(1.) - 2 Feet.
 - 2ft = ft *Perforation can not be closer then 1 foot from edge.*
- Determine the Number of Perforation Spaces. Divide the Length of Laterals(6.) by the Perforation Spacing (4.) and round down to the nearest whole number.
 Number of Perforation Spaces = ft \div ft = Spaces
- Number of Perforations per Lateral is equal to 1.0 plus the Number of Perforation Spaces(7.). Check table below to verify the number of perforations per lateral guarantees less than a 10% discharge variation. The value is double with a center manifold.

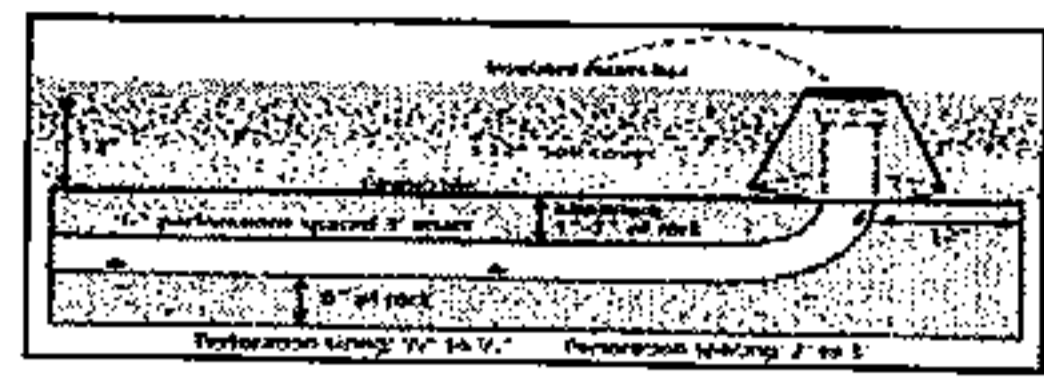

Perforations Per Lateral = Spaces + 1 = Perfs. Per Lateral

Maximum Number of Perforations Per Lateral to Guarantee <10% Discharge Variation											
1/4 Inch Perforations					7/32 Inch Perforations						
Perforation Spacing (Feet)	Pipe Diameter (Inches)					Perforation Spacing (Feet)	Pipe Diameter (Inches)				
	1	1 1/4	1 1/2	2	3		1	1 1/4	1 1/2	2	3
2	10	13	18	30	60	2	11	16	21	34	68
2 1/2	8	12	16	28	54	2 1/2	10	14	20	32	64
3	8	12	16	25	52	3	9	14	19	30	60
3/16 Inch Perforations					1/8 Inch Perforations						
Perforation Spacing (Feet)	Pipe Diameter (Inches)					Perforation Spacing (Feet)	Pipe Diameter (Inches)				
	1	1 1/4	1 1/2	2	3		1	1 1/4	1 1/2	2	3
2	12	18	26	46	87	2	21	33	44	74	149
2 1/2	12	17	24	40	80	2 1/2	20	30	41	69	135
3	12	16	22	37	75	3	20	29	38	64	128

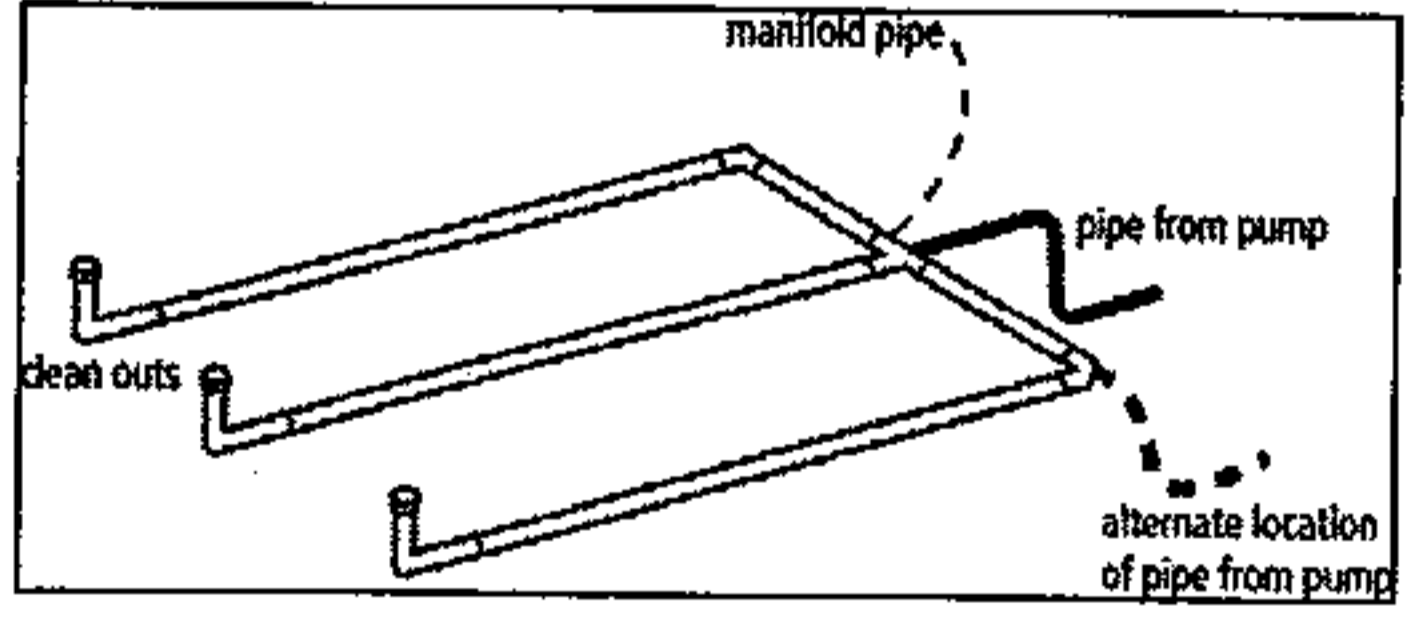

END Connection

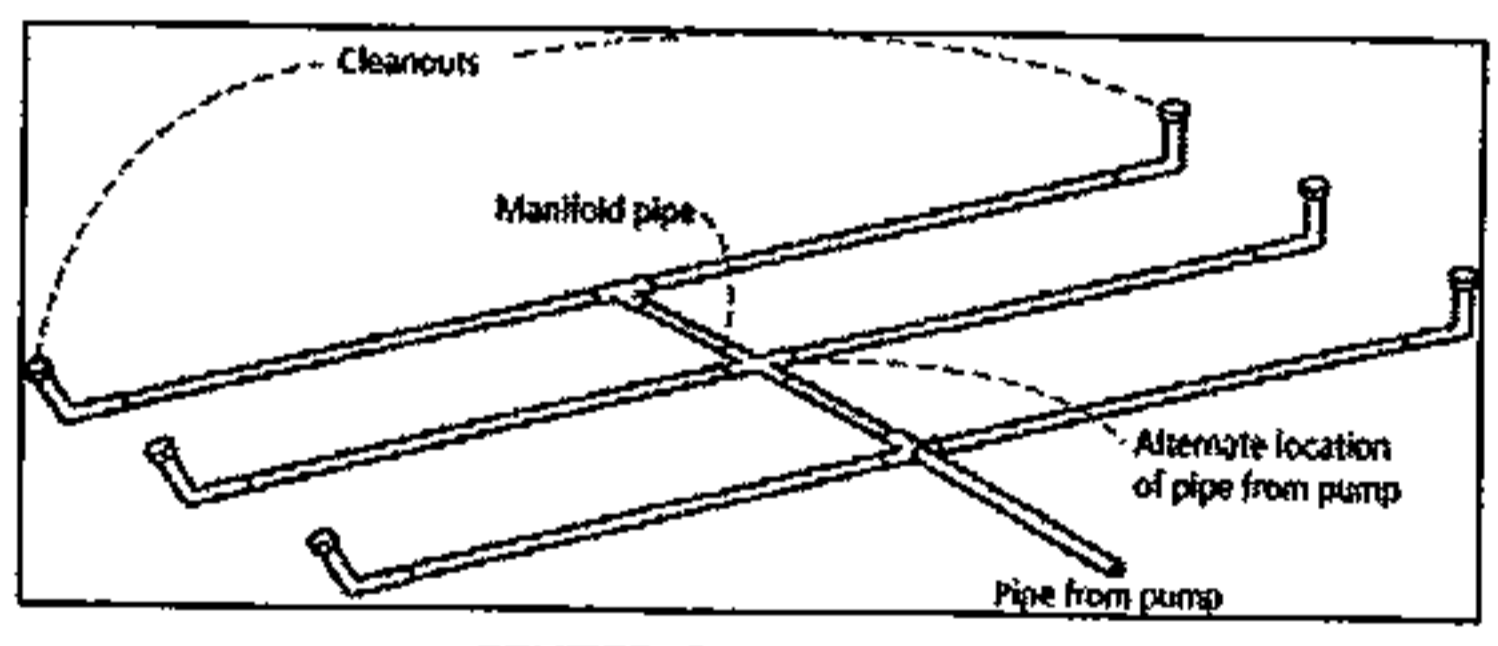

CENTER Connection

Perf Per Lateral:

Perf Per Lateral Equal Split: |

OPTIONAL Perf Per Lateral Non-Equal Split*: |
 * must not exceed maximum number perfs per lateral in table

- Total Number of Perforations equals the Number of Perforations per Lateral (8.) multiplied by the Number of Perforated Laterals.(3.)
 Perf. Per Lat. X Number of Perf. Lat. = Total Number of Perf.
- Spacing of laterals; Must be greater than 1 foot and no more than 3 feet: ft
- Select Type of Manifold Connection (End or Center): *If Center Manifold Connection the max number of perfs per lateral in the table can be doubled.*
- Select Lateral Diameter (See Table): in



13. Calculate the *Square Feet per Perforation*.

Recommended value is 4-11 ft² per perforation, Does not apply to At-Grades

a. *Bed Area* = Bed Width (ft) X Bed Length (ft)

10 ft X 25 ft = 250 sq.ft

b. *Square Foot per Perforation* = Bed Area ÷ by the Total Number of Perfs

250 sqft ÷ 24 perf = 10.4 sq.ft/perf

14. Select *Minimum Average Head*:

1.0 ft

15. Select *Perforation Discharge* based on Table:

0.74 GPM per Perf

16. *Flow Rate* = Total Number of Perfs(9.) X *Perforation Discharge*(15.)

24 Perfs X 0.74 GPM per Perforation = 18 GPM

17. *Volume of Liquid Per Foot of Distribution Piping* (Table II):

0.170 Gallons/ft

18. *Volume of Distribution Piping* = Number of Perforated Laterals(3.) X Length of Laterals(6.) X *Volume of Liquid Per Foot of Distribution Piping* (17.)

3 X 23 ft X 0.170 gal/ft = 11.7 Gallons

19. *Minimum Delivered Volume* = *Volume of Distribution Piping* X 4

11.7 gals X 4 = 46.9 Gallons

20. *Maximum Delivered Volume* = Design flow x 25%

300.0 gpd X 25% = 75.0 Gallons

21. *Minimum Delivered vs Maximum Delivered* evaluation:

Volume ratio correct

Head (ft)	Perforation Discharge (GPM)			
	Perforation Diameter			
	1/4	3/16	7/32	1/4
1.0'	0.18	0.41	0.56	0.74
1.5	0.22	0.51	0.69	0.9
2.0'	0.26	0.59	0.80	1.04
2.5	0.29	0.65	0.89	1.17
3.0	0.32	0.72	0.98	1.28
4.0	0.37	0.83	1.13	1.47
5.0'	0.41	0.93	1.26	1.65
1 foot	Dwellings with 3/16 inch to 1/4 inch perforations			
2 feet	Dwellings with 1/8 inch perforations Other establishments and AGTS with 3/16 inch to 1/4 inch perforations			
5 feet	Other establishments and AGTS with 1/8 inch perforations			

Pipe Diameter (Inches)	Liquid Per Foot (Gallons)
1	0.045
1.25	0.078
1.5	0.110
2	0.170
3	0.380
4	0.661

Comments/Special Design Considerations:

1. PUMP CAPACITY Project ID: _____ v 03.15.2023

Pumping to Gravity or Pressure Distribution:

A. If pumping to gravity enter the gallon per minute of the pump: GPM (10 - 45 gpm)

B. If pumping to a pressurized distribution system: GPM

C. Enter pump description:

2. HEAD REQUIREMENTS

A. Elevation Difference ft between pump and point of discharge:

B. Distribution Head Loss: ft

C. Additional Head Loss*: ft (due to special equipment, etc.)
 * Common additional head loss: gate valve = 1 ft each, globe valve = 1.5 ft each, splitter valve = see manufacturers details

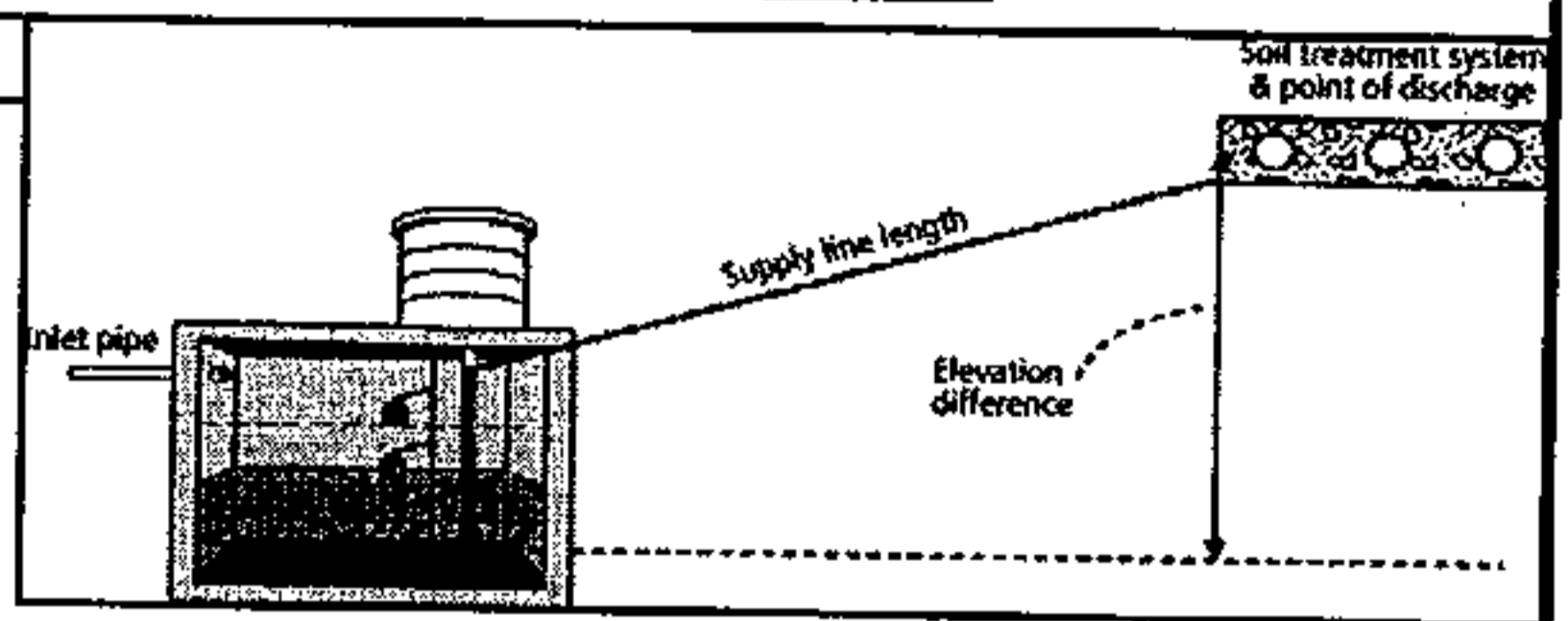

Distribution Head Loss	
Gravity Distribution = 0ft	
Pressure Distribution based on Minimum Average Head Value on Pressure Distribution Worksheet:	
Minimum Average Head	Distribution Head Loss
1ft	5ft
2ft	6ft
5ft	10ft

Flow Rate (GPM)	Pipe Diameter (inches)			
	1	1.25	1.5	2
10	9.1	3.1	1.3	0.3
12	12.8	4.3	1.8	0.4
14	17.0	5.7	2.4	0.6
16	21.8	7.3	3.0	0.7
18		9.1	3.8	0.9
20		11.1	4.6	1.1
25		16.8	6.9	1.7
30		23.5	9.7	2.4
35			12.9	3.2
40			16.5	4.1
45			20.5	5.0
50				6.1
55				7.3
60				8.6
65				10.0
70				11.4
75				13.0
85				16.4
95				20.1

D. 1. Supply Pipe Diameter: in

2. Supply Pipe Length: ft

E. Friction Loss in Plastic Pipe per 100ft from Table I:

Friction Loss = ft per 100ft of pipe

F. Determine Equivalent Pipe Length from pump discharge to soil dispersal area discharge point. Estimate by adding 25% to supply pipe length for fitting loss.
 Supply Pipe Length X 1.25 = Equivalent Pipe Length

ft X 1.25 = ft

G. Calculate Supply Friction Loss by multiplying Friction Loss Per 100ft(E.) by the Equivalent Pipe Length(F.) and divide by 100.

Supply Friction Loss = ft per 100ft X ft ÷ 100 = ft

H. Total Head requirement is the sum of the Elevation Difference(2A) + Distribution Head Loss(2B) + Additional Head Loss(2C) + Supply Friction Loss(2G)

ft + ft + ft + ft = ft

3. PUMP SELECTION

A pump must be selected to deliver at least **18.0** GPM with at least **16.3** feet of total head.

Comments:



STA Dosing Pump Tank Design Worksheet (Demand Dose)

DETERMINE TANK CAPACITY AND DIMENSIONS		Project ID:	v 03.15.2023
1. A. Design Flow (Design Sum. 1A):	<input type="text" value="300"/> GPD	C. Tank Use:	<input type="text" value="Dosing"/>
B. Min. required pump tank capacity:	<input type="text" value="500"/> Gal	D. Recommended pump tank capacity:	<input type="text" value="1000"/> Gal
2. A. Tank Manufacturer:	<input type="text" value="BROWN WILBERT"/>	B. Tank Model:	<input type="text" value="1000"/>
C. Capacity from manufacturer:	<input type="text" value="1089"/> Gallons	<i>Note: Design calculations are based on this specific tank. Substituting a different tank model will change the pump float or timer settings. Contact designer if changes are necessary.</i>	
D. Gallons per inch from manufacturer:	<input type="text" value="22.0"/> Gallons per inch		
E. Liquid depth of tank from manufacturer:	<input type="text" value="48.0"/> inches		

DETERMINE DOSING VOLUME	
3. Calculate <i>Volume to Cover Pump</i> (The inlet of the pump must be at least 4-inches from the bottom of the pump tank & 2 inches of water covering the pump is recommended) (Pump and block height + 2 inches) X Gallons Per Inch (2D) (<input type="text" value="14"/> in + 2 inches) X <input type="text" value="22.7"/> Gallons Per Inch = <input type="text" value="363"/> Gallons	
4. <i>Minimum Delivered Volume</i> = 4 X Volume of Distribution Piping: -Item 19 of the Pressure Distribution STA or Item 11 of Non-level STA <input type="text" value="47"/> Gallons (Minimum dose) <input type="text" value="2.1"/> inches/dose	
5. Calculate <i>Maximum Pumpout Volume</i> (25% of Design Flow(1A)) Design Flow: <input type="text" value="300"/> GPD X 0.25 = <input type="text" value="75"/> Gallons (Maximum dose) <input type="text" value="3.3"/> inches/dose	
6. Select a pumpout volume that meets both Minimum and Maximum: <input type="text" value="74"/> Gallons	
7. Calculate <i>Doses Per Day</i> = Design Flow(1A) ÷ Delivered Volume(6.) <input type="text" value="300"/> gpd ÷ <input type="text" value="74"/> gal = <input type="text" value="4.05"/> Doses* * Doses need to be equal to or greater than 4	
8. Calculate Drainback: A. Diameter of Supply Pipe = <input type="text" value="2"/> inches B. Length of Supply Pipe = <input type="text" value="30"/> feet C. Volume of Liquid Per Lineal Foot of Pipe = <input type="text" value="0.170"/> Gallons/ft D. Drainback = Length of Supply Pipe(8B) X Volume of Liquid Per Lineal Foot of Pipe(8C) <input type="text" value="30"/> ft X <input type="text" value="0.170"/> gal/ft = <input type="text" value="5.1"/> Gallons	
9. <i>Total Dosing Volume</i> = Delivered Volume(6.) + Drainback (8D) <input type="text" value="74"/> gal + <input type="text" value="5.1"/> gal = <input type="text" value="79"/> Gallons	
10. <i>Minimum Alarm Volume</i> = Depth of alarm (2 or 3 inches) X gallons per inch of tank(2D) <input type="text" value="3"/> in X <input type="text" value="22.7"/> gal/in = <input type="text" value="68.1"/> Gallons	
11. <i>Reserve Capacity Volume</i> = [Tank Liquid Depth(2E) - Alarm Float Depth(10.)] x gallons per inch of tank(2D) [<input type="text" value="48.0"/> in - <input type="text" value="22.6"/> in] X <input type="text" value="22.0"/> gal/in = <input type="text" value="558.9"/> Gallons	

Volume of Liquid in Pipe	
Pipe Diameter (inches)	Liquid Per Foot (Gallons)
1	0.045
1.25	0.078
1.5	0.110
2	0.170
3	0.380
4	0.661

DEMAND DOSE FLOAT SETTINGS		Alarm and Pump are to be wired on separate circuits and inspected by the electrical inspector	
12. Calculate <i>Float Separation Distance</i> using <i>Dosing Volume</i> . Total Dosing Volume(9.) ÷ Gallons Per Inch(2D) <input type="text" value="79"/> gal ÷ <input type="text" value="22.0"/> gal/in = <input type="text" value="3.6"/> inches			
13. Measuring from bottom of tank:			
A. Distance to set Pump Off Float = Pump + block height + 2 inches	<input type="text" value="14"/> in + 2 in = <input type="text" value="16"/> inches	Inches for Dose:	<input type="text" value="3.6"/> in
B. Distance to set Pump On Float = Distance to Set Pump-Off Float(13A) + Float Separation Distance(12.)	<input type="text" value="16"/> in + <input type="text" value="3.6"/> in = <input type="text" value="20"/> inches	Alarm Depth	<input type="text" value="22.6"/> in
C. Distance to set Alarm Float = Distance to set Pump-On Float(13B) + Alarm Depth (2-3 inches)(10.)	<input type="text" value="20"/> in + <input type="text" value="3.0"/> in = <input type="text" value="23"/> inches	Pump On	<input type="text" value="19.6"/> in
		Pump Off	<input type="text" value="16.0"/> in

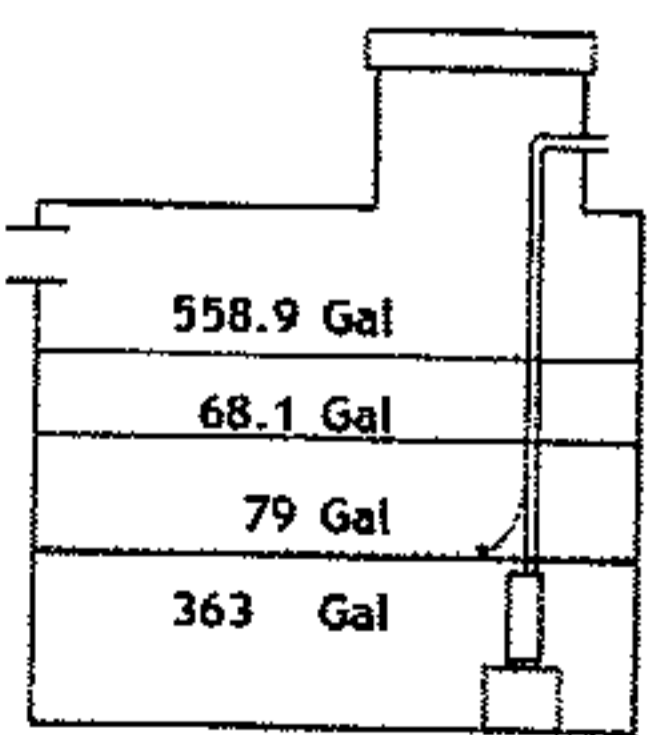

MONITORING AND MITIGATION

SEPTIC SYSTEM CLASSIFIED AS TYPE III

Should the system fail a new site for the septic system may be considered or the owner agrees to repair the septic system if it is possible. If the septic system is not repairable the homeowner agrees to disconnect the septic tanks from the septic system and use and maintain the septic tanks as holding tanks.

Pine County and Kevin Herwig are to be notified as soon as possible about any operational problems. If a failure occurs the septic pump must be disconnected immediately and remain disconnected until all repairs are completed. A pumping contract will need to be set up with a septic maintenance contractor. A copy of all documents must be submitted to the county.

The system must be monitored for a minimum of three years. The mound system is to be inspected by the homeowner for leaks or saturated areas. Inspections are to be done every month for 36 months. Any leaks or failures in the system must be reported to the county within 24 hours.

All expenses for repair or replacement are the homeowner's responsibility.

Type III systems are not warranted by the Inspector, Designer, or Installer

I _____, property owner of 63170 Grouse Trail Sandstone Mn.

Hereby agree that as long as I am the owner of the property, to accept all legal and financial responsibility for future system repair and/or replacement expense in the event that failure of the system on the above referenced property occurs.

Owner

Date

Owners Septic System Management Plan

Date: 6/9/2023

Property Address: 63170 Grouse Trail Sandstone Mn.

Septic Systems can be an expensive investment, good maintenance will ensure they last a lifetime. The purpose of a septic system is to properly "decompose" the pollutants before the water is recycled back into the groundwater. If you're not taking this seriously, ask yourself where your well water comes from.

Your septic design lists all the components of your system and their location. Keep the design, this management plan and the UofM "Septic System Owners Guide" in a safe place for future reference. For a copy of the Owners guide call the University of MN at 1-800-876-8636.

Some of the following tasks you can do yourself, some require a professional, but is it YOUR responsibility to see that it gets done.

Homeowner Tasks

- Do your best to conserve water. Don't overload your septic with multiple large water uses at the same time or on the same day.
- Fix household leaks promptly (leaky toilet, dripping faucets).
- Limit bleach and anti-bacterial products. Use Biodegradable dishwasher detergent.
- Consider a lint filter on your clothes washer.
- Regularly check for wet or spongy soil around your drainfield.
- Have a septic professional check your tanks every 3 years to determine if they need pumping.
- If you have a septic tank filter (effluent filter) clean it on a regular basis (or have a professional do it).
- If a septic alarm goes off, call your septic professional to diagnose the problem.
- Notify the County/City/Township when this management plan is not being met.
- Be aware of and protect your secondary drainfield site.

Professional Tasks

- Disclose the location of the secondary drainfield (if applicable).
- Respond to alarms and diagnose problems as needed.
- Review water use with the owner, check for a "soggy" drainfield.
- Pump the septic tanks as needed and ensure they are in proper working order.
- Verify the pump, dose amount, HI Level Alarm & drainback are all working properly.

"As the owner, I understand it is my responsibility to properly operate and maintain this septic system".

Property Owner Signature: _____ **Date** _____